

CARDIOVASCULAR & THORACIC INSTRUMENTS

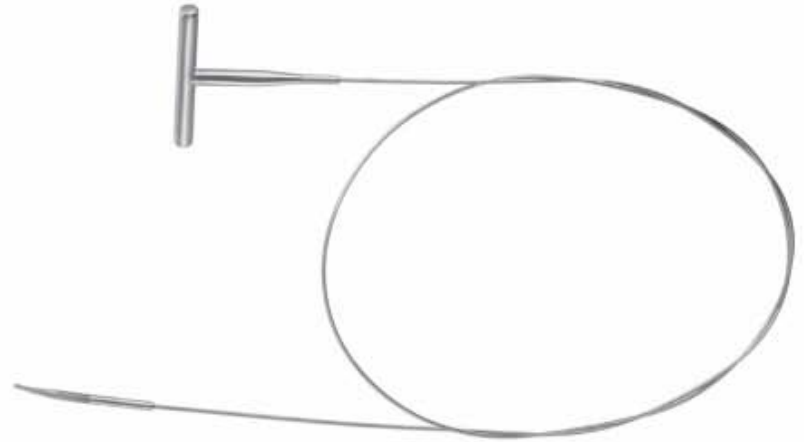

VARICOSE VEIN PROBE SET

Krampfaderbesteck | *Juego para varices*
Trousse a varices | *Astuccio per varici*



Nabatoff Varicose Vein Stripper

12-001
 135mmx100mmx25mm
 complete

12-002
Nabatoff
 Metal Case

12-003
Nabatoff
 Handle

12-004
Nabatoff
 Cable 900mm



3mm



6mm



9mm



12mm

12-005
Nabatoff
 Probe tip in plastic



Nabatoff
 Metal Probe
12-006
 3mm



Nabatoff
 Metal Olive
12-007
 6mm



Nabatoff
 Metal Olive
12-008
 9mm



Nabatoff
 Metal Olive
12-009
 12mm



Nabatoff
 Metal Olive
12-010
 15mm

Atrauma Mikro-Bulldogklemmen

Micro-Clamps Bulldog à mors Atrauma

Micro-Clamps Bulldog con bocas Atrauma

Attrae i morsetti Micro Bulldog



De Bakey

12-011
7.5 cm



12-012
8.5 cm



12-013
10 cm



12-014
12 cm



De Bakey



12-015
7.5 cm



12-016
8.5 cm



12-017
9.5 cm



12-018
11 cm



Glover



12-020
7 cm



12-021
8 cm



12-022
9.5 cm



12-023
11 cm



Applying forceps for bulldog clamps
12-019
24 cm



Glover



12-024
6.5 cm



12-025
7.5 cm



12-026
9 cm



12-027
10.5 cm

VASCULAR FORCEPS

Gefäßklemmen | Pinzas vasculares

Pinces vasculaires | Pinze vascolari



Hemostatic forceps



De Bakey-Rankin
16 cm



12-049
Straight



12-050
Curved



De Bakey-Mosquito
15 cm



12-051
Straight



12-052
Curved



Ochsner
12-053
22 cm



Diethrich
12-054
21 cm

COARCTATION CLAMPS

Coarctationsklemmen | Pincas-Clamps pour coarctation
 Pinzas para coarctación | Morsetti di Coartazione



12-055
21 cm
30 mm

Potts



12-056
22.5 cm
55 mm



Potts



12-057
20.5 cm
angled
30 mm

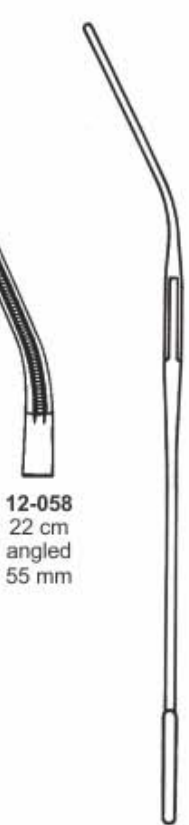

12-058
22 cm
angled
55 mm



Potts

12-059
20.5 cm
angled
30 mm



12-060
22 cm
angled
55 mm



Potts
12-061
21.5 cm
55 mm



Anastomosenklemmen, Ligaturklemmen

Pinces-clamps à anastomose, Pinces à ligatures

Pinzas para anastomosis, Pinzas para ligaduras

Morsetti per anastomosi, pinze per legature



Potts
12-062
22 cm
55 mm



De Bakley



12-063
19 cm



12-064
24 cm



De Bakley
12-065
16 cm



De Bakley
12-066
19 cm

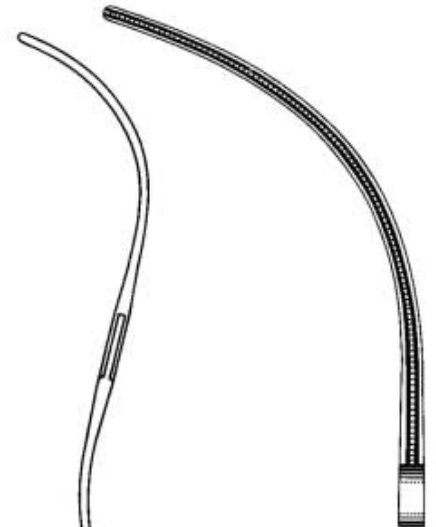

Peripheral-Gefäßklemmen
Pinzas para vasos periféricos

Pinces-clamps vasculaires périphériques
Morsetti vascolari periferici

Multi purpose Vascular Clamps



De Bakey
12-067
20 cm

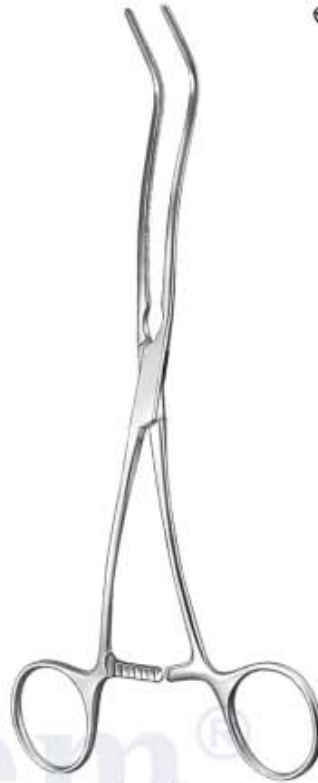

De Bakey
12-068
angled, 20 cm

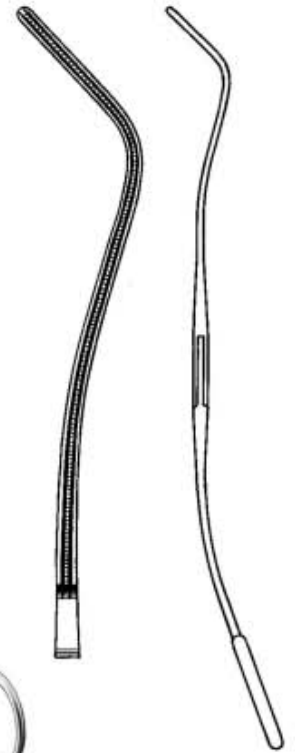

Leland-Jones

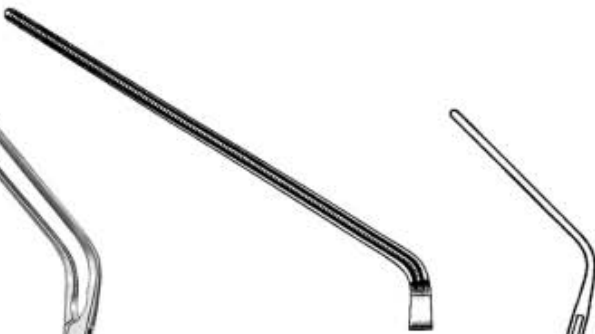

12-069
18 cm



12-070
19 cm



12-071
20 cm

MULTI PURPOSE VASCULAR CLAMPS



Bainbridge



12-072
15 cm



12-073
18.5 cm



Bainbridge



12-074
15 cm



12-075
18.5 cm



De Bakey



12-076
26 cm



12-077
27 cm



12-078
31 cm



12-079
33 cm



TANGENTIAL OCCLUSION FORCEPS

Tangential-Verschlussklemmen | Pincas vasculaires pour occlusion tangentielle
 Pinzas tangentes de oclusión | Morsetti di occlusione tangenziale

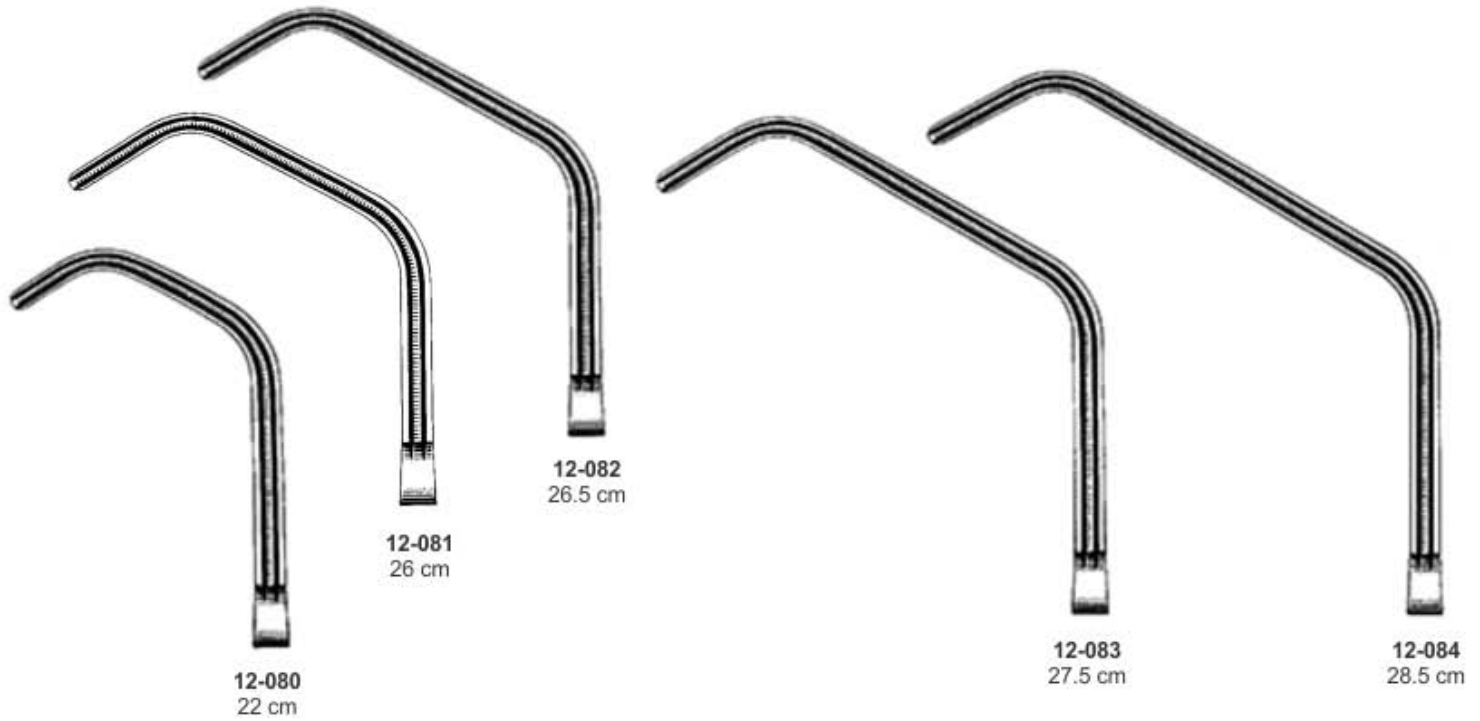

Aneurysm Clamps



Mehrzweck-Gefäßklemmen

Pinces vasculaires universelles

Pinzas vasculares de usos múltiples

Morsetti vascolari multiuso



Potts straight



12-088
21.5 cm



12-089
23.5 cm



12-090
27 cm



12-091
31.5 cm



Potts curved



12-092
21 cm



12-093
23 cm



12-094
26 cm

12-095
31 cm



De Bakey

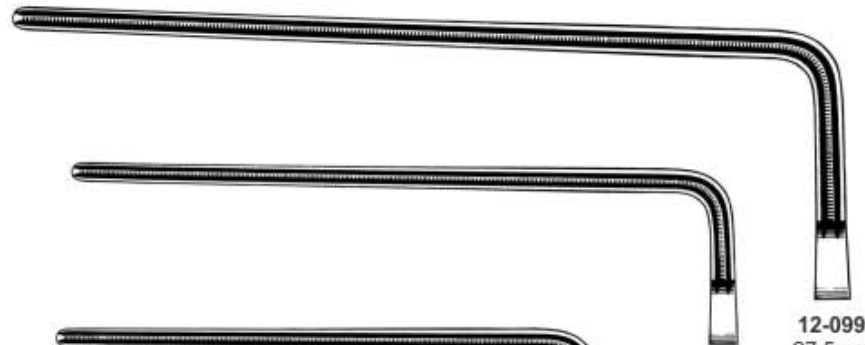

12-099
27.5 cm

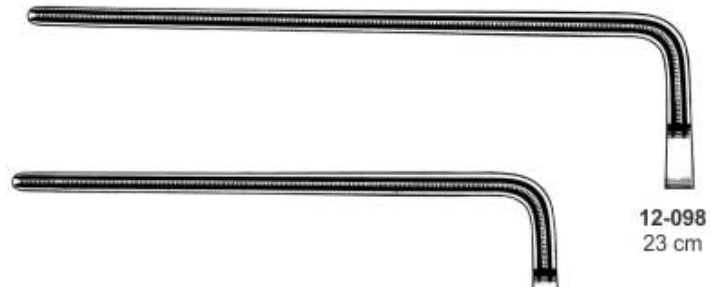

12-098
23 cm



12-097
20 cm



12-096
19 cm

MULTI PURPOSE VASCULAR CLAMPS

Mehrzweck-Gefäßklemmen

Pinces vasculaires universelles

Pinzas vasculares de usos múltiples

Morsetti vascolari multiuso



De Bakey



12-100
21 cm

12-101
22 cm

12-102
26 cm

12-103
31.5 cm



De Bakey
12-104
straight
17.5 cm



De Bakey



12-105
strongly
angled
15 cm



De Bakey Beck
12-106
17 cm

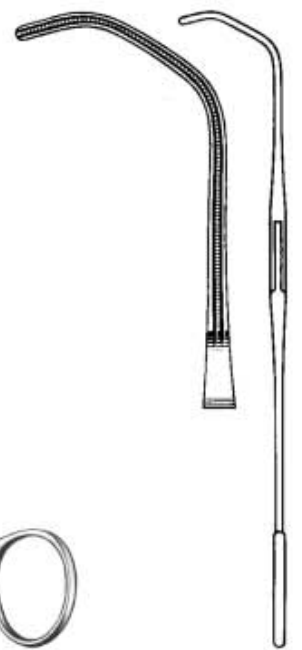

Anastomosis Clamps



**Glover
12-107**
curved
17 cm

**Glover
12-108**
spoon-shape
17.5 cm

De Bakey®

12-110
16.5 cm

12-109
16.5 cm



12-111
16.5 cm

12-112
17 cm

12-113
17.5 cm

Derra

Kinder-Gefäßklemmen

Pinces vasculaires pédiatriques

Pinzas vasculares pediátricas

Morsetti vascolari pediatrici

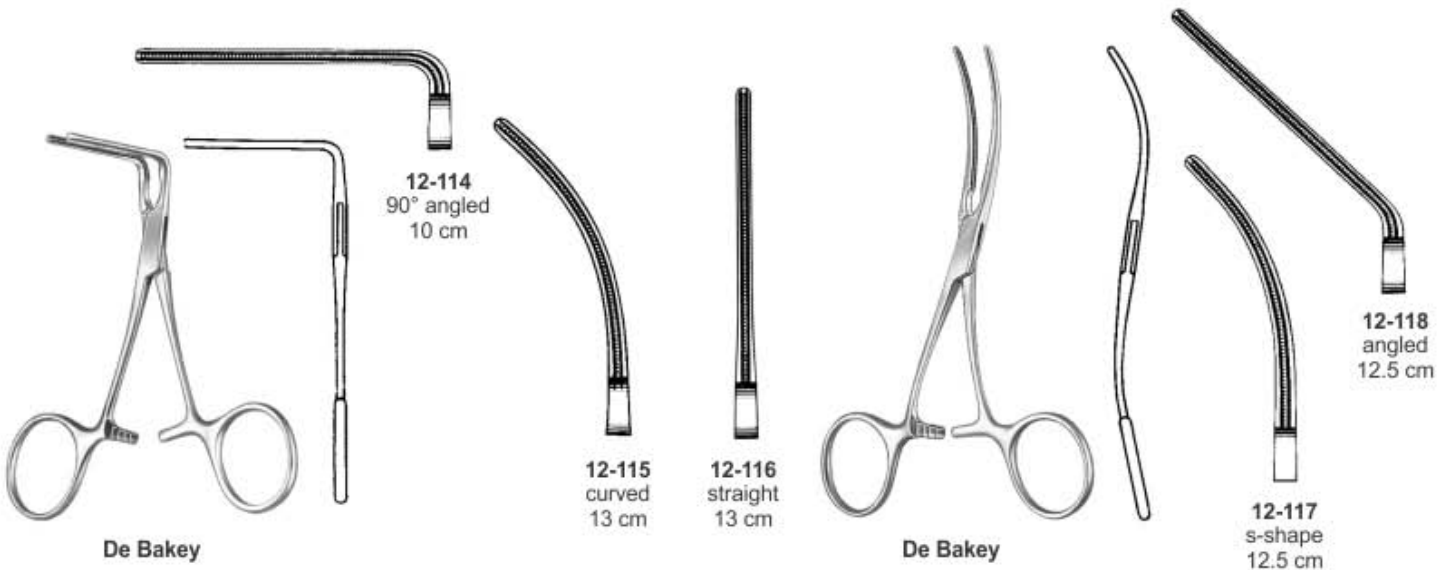

SurZem®

Anastomosis Clamps



Neonatal Vascular Clamps



Castaneda Multipurpose Clamp & Atraumatic Cardiovascular Forceps

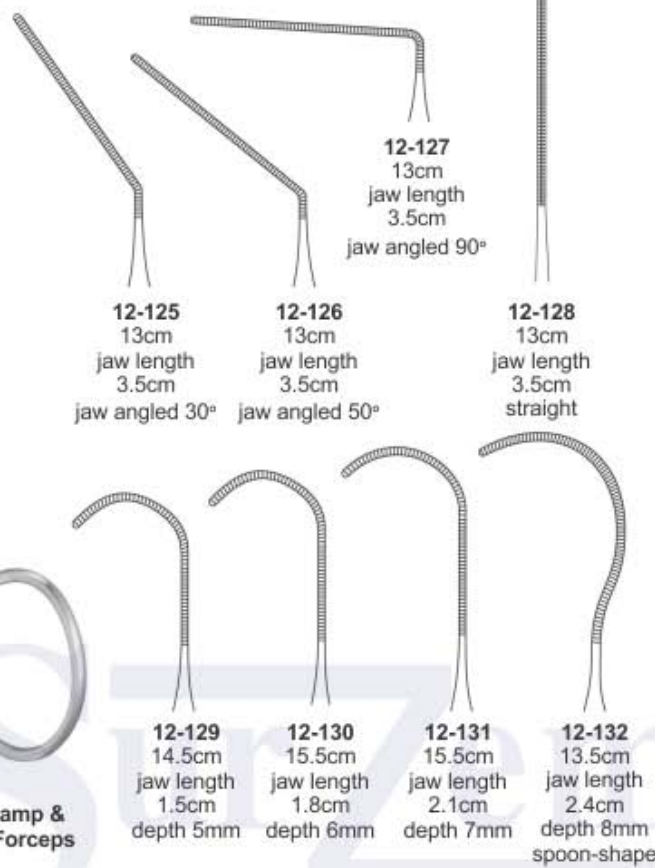

12-125
13cm
jaw length 3.5cm
jaw angled 30°

12-126
13cm
jaw length 3.5cm
jaw angled 50°

12-127
13cm
jaw length 3.5cm
jaw angled 90°

12-128
13cm
jaw length 3.5cm
straight

12-129
14.5cm
jaw length 1.5cm
depth 5mm

12-130
15.5cm
jaw length 1.8cm
depth 6mm

12-131
15.5cm
jaw length 2.1cm
depth 7mm

12-132
13.5cm
jaw length 2.4cm
depth 8mm
spoon-shape



Cooley 12-133
curved sidewards
17 cm



Cooley 12-134
double curved
16 cm



12-135
straight angled
14.5 cm



12-136
medium angled
16 cm



12-137
slight angled
16.5 cm

Rippenkontraktoren
Aproximadores para costillas

Rapprocheurs des côtes
Approssimatori costali



**Bailey-Gibbon
Rib Contractors
12-138
20 cm
For Adult**



**Bailey-Gibbon
Rib Contractors
12-139
20 cm
For children**



**Bailey-Baby
Rib Contractors
12-140
15 cm**



**Sellers Rib Contractor
12-141 20 cm**



**Blalock
Rib Contractors**



**12-142
15 cm**



**12-143
20 cm**

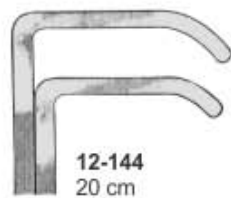

**12-144
20 cm**



**Johns-Hopkins
(Potts Modif.)
Rib Contractors**



**12-145
20 cm**



**12-146
20 cm**



**12-147
20 cm**

Lungenspatel, Aorta-Dilatatoren

Spatules pulmonaires, Dilatateurs pour aorte

Espátulas pulmonares, Dilatadores aórticos

Spatole per pulmone, Dilatatori per aorta



Allison Lung Spatula Retractor
 12-148 25 cm
 12-149 30 cm
 12-150 32 cm
 wide 3.8cm
 Small Size

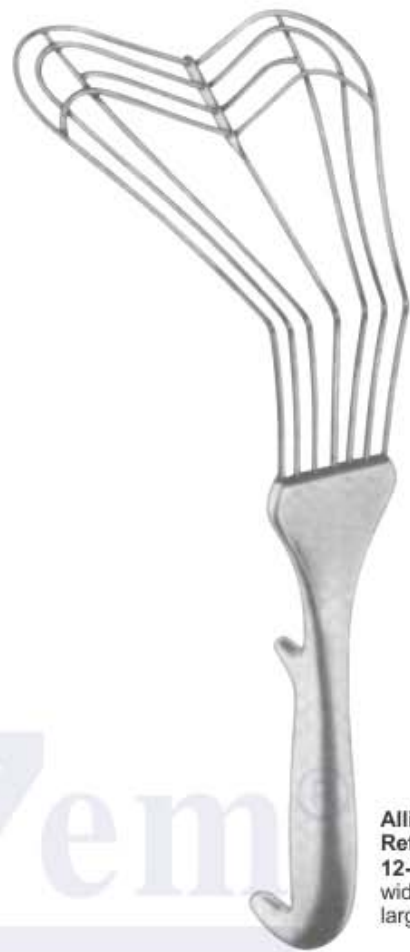

Allison Lung Spatula Retractor
 12-151 32.4 cm
 wide 5.2cm
 large size

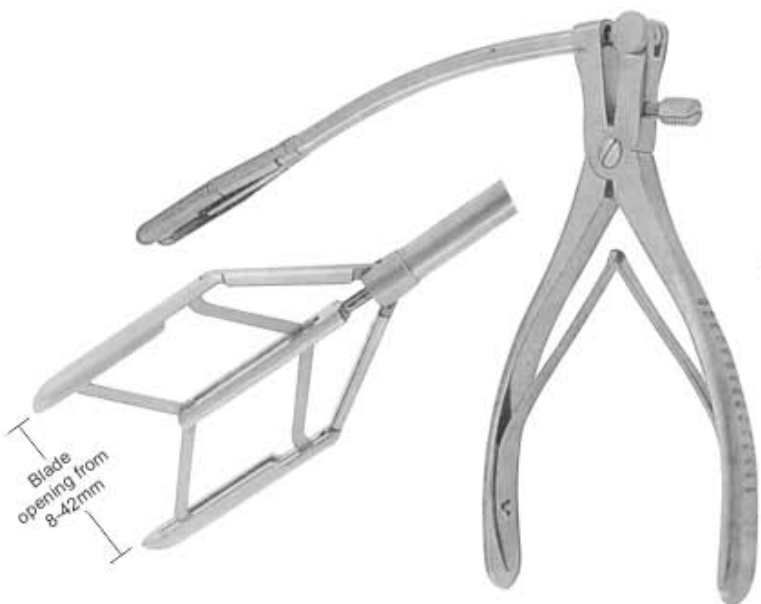

Tubbs Mitral Valve Aortic Dilator
 12-152
 Blade Opening
 From 8 To 42 mm



Cooley Blade Aortic Dilator
 12-153
 Blade Opening
 From 8 To 15 mm

Rippensperrer | Ecarteur de côtes
 Separador costal | Divaricatore costale



Morse 12-154
 Sternal Retractor 4 movable
 blades 22 x 27mm spreading 200 mm
 Size 1,



DeBakey 12-155
 Rib Retractor spreading 150 mm
 Size 1,



DeBakey 12-156
 Rib Retractor spreading 200 mm
 Size 1,



Cherry 12-157
 mm mm mm
 44 70 135



Cooley Rib Retractors 12-158
 lateral blades 12 x 16 mm spreading 95 mm



Cooley Rib Retractors 12-159 lateral blades 15 x 30 mm, spreading 140 mm
12-160 lateral blades 21 x 44 mm, spreading 150 mm



Cooley Rib Retractors

12-161

lateral blades 35 x 50 mm, spreading 200 mm

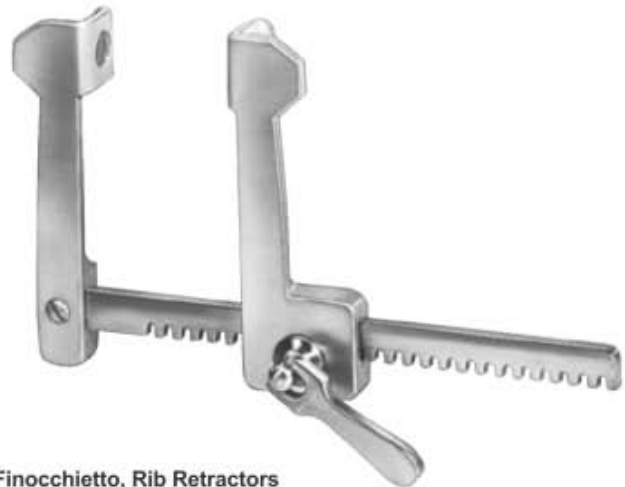

Finocchetto, Rib Retractors

12-162 lateral blades 15 x 15 mm, spreading 75 mm, infant

12-163 lateral blades 31 x 31 spreading 100 mm, baby - height

12-164 lateral blades 40 x 45 spreading 135 mm, baby - height

12-165 lateral blades 52 x 62 spreading 175 mm, baby - height

12-166 lateral blades 84 x 65 spreading 175 mm, baby - height



Haight Rib Retractor

12-167

lateral blades 30 x 30 mm, spreading 120 mm



Morse-Favaloro Sternal Retractor

12-168

4 movable blades 17 x 22 mm, spreading 160mm for children



Finocchetto (Modif.) Rib Retractors

12-169

lateral blades 14 x 15 mm, spreading 120 mm



Tuffier Rib Retractor

12-170

lateral blades 45 x 45 mm, spreading 160 mm

12-171

lateral blades 22 x 27 mm, spreading 200 mm

Rippensperrer | Ecarteur de côtes
 Separador costal | Divaricatore costale

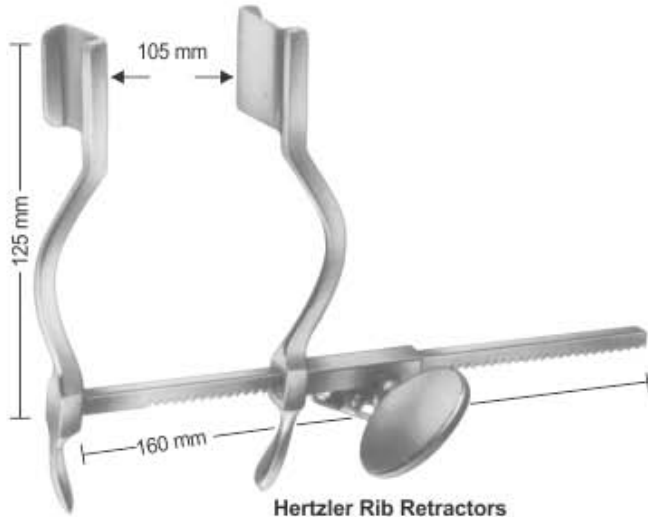

Hertzer Rib Retractors
12-172
 blades 20 x 25 mm, spreading 105 mm

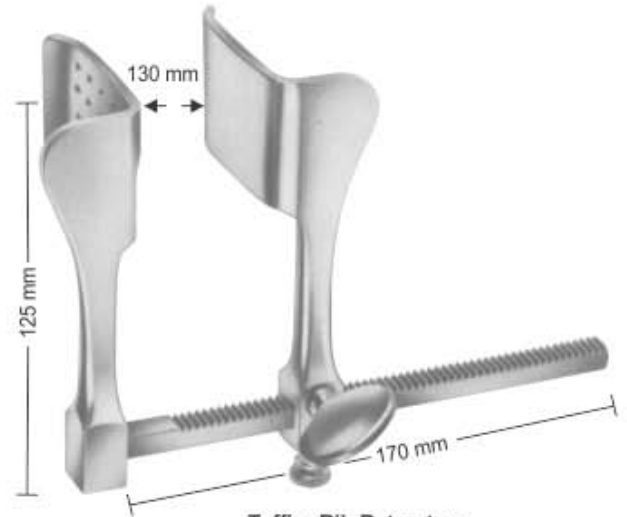

Tuffier Rib Retractors
12-173
 blades 43 x 53 mm, spreading 130 mm



Thoracic Rib Retractors
12-174 Retractor only
12-175 pair of blades, 48 x 68 mm
12-176 1 pair of blades, 70 x 75 mm



Thoracic & I.M.A Rib Retractors
12-177 Complete set
12-178 lateral blades for I.M.A Retractor
 left 40 x 50 x 80 mm
12-179 lateral blades for I.M.A Retractor
 Right 40 x 50 x 80 mm

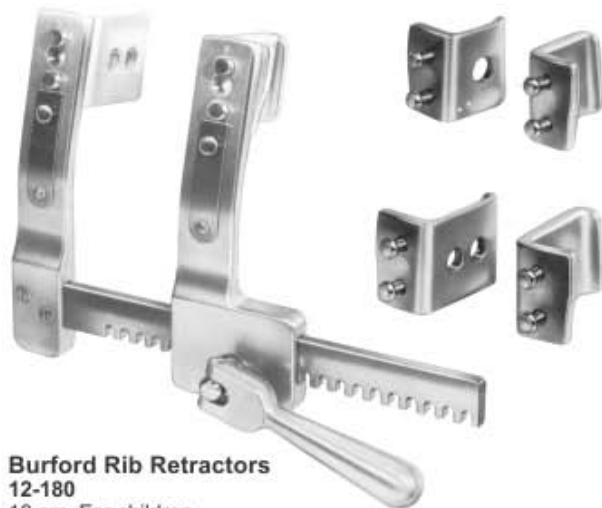

Burford Rib Retractors
12-180
 18 cm For children
 spread with 2 sets of Blades
12-181 48 mm x 42 mm spreading 135 mm
12-182 38 mm x 42 mm spreading 135 mm



Burford Rib Retractors
12-183
 18 cm For Adults
 spread with 2 sets of Blades
12-184 with two pair of blade 47 x 62 mm + 65 x 62 mm spreading 200 mm
12-185 with 2 pair of blade 47 x 62 mm + 65 x 62 mm spreading 260 mm
12-186 with 2 pair of blade 47 x 62 mm + 65 x 62 mm spreading 300 mm

Rippensperrer

Ecarteur de côtes

Separador costal

Divaricatore costale

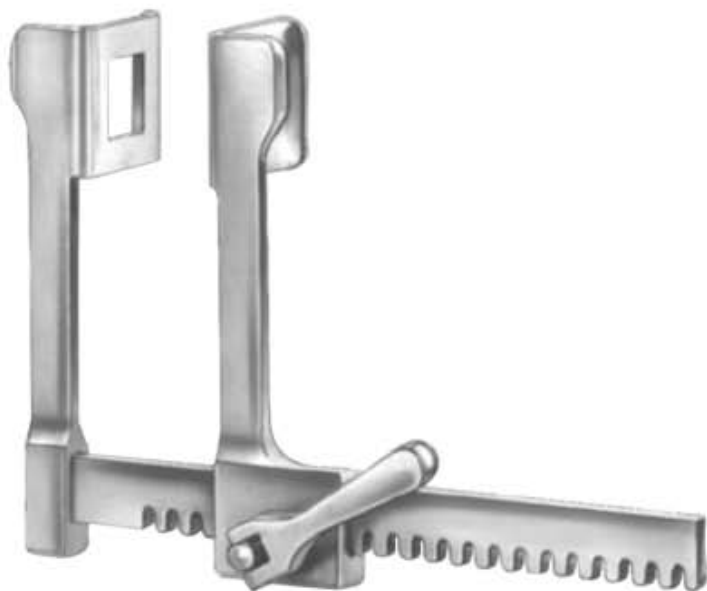

Finocchetto/Baby Rib Retractors
12-187 7.5 cm
 14 mm x 15 mm spreading 75 mm



Finocchetto, Rib Retractors
 20 cm
12-188 30 mm x 45 mm spreading 150 mm
12-189 46 mm x 62 mm spreading 190 mm
12-190 80 mm x 65 mm spreading 190 mm



Castaneda Rib Retractors
12-191 10.5 mm x 32 mm
 spreading 65 mm



Castaneda Rib Retractors
12-192 12 mm x 45 mm
 spreading 70 mm

Castaneda Rib Retractors
12-193 15 mm x 60 mm
 spreading 120 mm

RIB SHEARS, STERNUM CHISEL

Rippenscheren, Sternummeißel	Costotomes, ciseau-Burin à sternum
Costotomos, Cinceles	Costotomi, Scalpello per sterno



Sauerbruch-Frey Rib Shears
12-194
for the first rib
37 cm



Schumacher Rib Shears
12-195
sternum shears
21 cm



Bone Rib Shear
12-196
23 cm



Rib Shear
12-197
23 cm



Gluck Rib Shear
12-198
22 cm



Lebsche Sternum Chisel
12-199 24.5 cm



Semb Rib Shears
12-200 20 cm



Semb Rib Shears
12-201 20 cm

Rippenscheren, Sternummeißel
Costotomos, Cinceles

Costotomes, ciseau-Burin à sternum
Costotomi, Scalpello per sterno

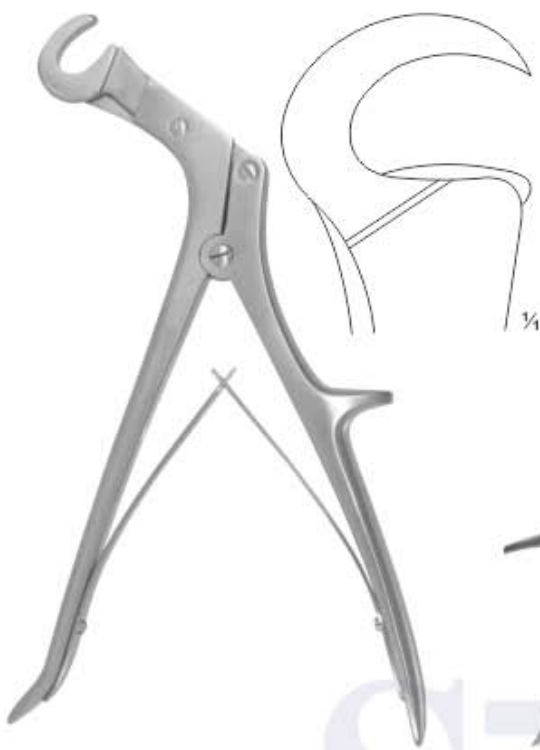

Giertz-Stille Rib Shears
12-202 27 cm

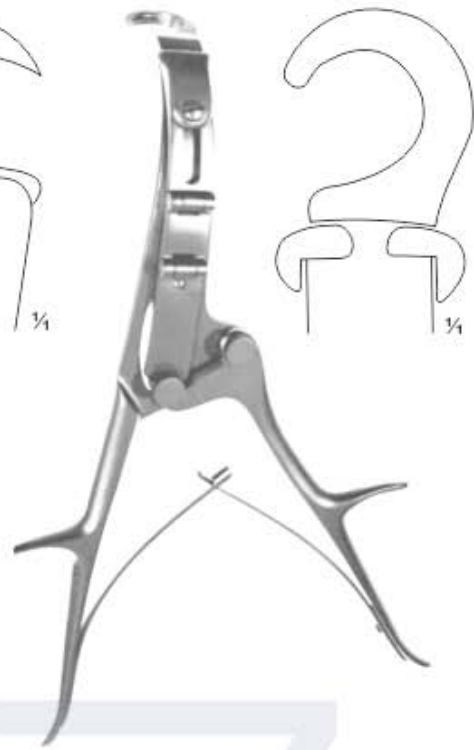

Brunner Rib Shears
12-203 33.5 cm



Maurer-Collin Rib Shears



12-204
Hooked Left
23 cm



12-205
Hooked Right
23 cm



Sauerbruch Rib Shears
12-206 24 cm, For Children
12-207 27 cm, For Adults



Schuardt Rib Shears
12-208 17 cm



Collin Rib Shears
12-209 19 cm



Doyen Rib Shears
12-210 19 cm